



| ENVIRONMENTALLY TRAINED |

LUBRICANTS FOR RAILWAY TRAFFIC



FOREWORD	3
WHEEL FLANGE LUBRICATION (ON BOARD)	4
RAIL LUBRICATION (TRACK-SIDE)	7
RAIL HEAD TREATMENT	10
SWITCH LUBRICATION	13
MAINTENANCE, REPAIR, CARE	15
PRODUCTS AND APPLICATION AREAS	16
SELECTION GUIDE	18

■ **WITH REFERENCE TO THE TECHNICAL BROCHURE:** The information in this brochure corresponds with the status of our momentary development and knowledge. Subject to alteration.

■ **WITH REFERENCE TO THE PHOTOS:** We thank all our customers for the photos they put at our disposal, as well as all the other companies who supported us with photographic material.

ENVIRONMENTAL PROTECTION WITHOUT COMPROMISES

■ **NOWADAYS IN MANY TECHNICAL AREAS**, biologically degradable lubricants make an important contribution by providing the best possible method of dealing with friction points while at the same time providing the greatest possible degree of protection to the environment. The purposeful use of a traditional lubricant already benefits the environment by lessening friction, reducing noise and wear and saving energy. If, however, one introduces efficient, environmentally harmless lubricants, there is also a visible reduction in the adverse effects upon water, air and soil. Some statistics on the subject: the global consumption of lubricants amounts to about 37 million tonnes, of which about 1.2 million are in Germany alone. The proportion of pure loss lubricants amounts to circa 40,000 tonnes. As far as the diverse, environmentally sensitive lubrication points on switches, rails and wheel flanges are concerned, estimates for the total requirement in Germany start from well over a thousand tonnes per year. However, it is decisive for the use of environmentally

harmless lubricants that they must be at least of the same quality than conventionally based lubricants, so that the benefit of biodegradability is not achieved at the expense of technical performance. In this case a higher dose would have to compensate, which would again not be beneficial for the environment.

Environmentally harmless lubricants from FUCHS LUBRITECH are therefore not compromises, but are trimmed to optimal performance right from the very beginning. Good biodegradability is an additional plus.

For more than three decades FUCHS LUBRITECH has devoted itself to the development of biodegradable lubricants. From early on fully synthetic base oils, which from the point of view of efficiency are clear-

ly superior to the native products, took centre stage in this. For it is precisely in such highly sensitive applications such as the lubrication of rails and switches that the technical efficiency must not lag behind the environmental compatibility. The result of ambitious development work: an elaborate programme of special lubricants for all areas of wheel-rail contact. Included in this are universally applicable wheel flange lubricants as well as lubricants for the rail flanks, designed for use with special application techniques, or long-term lubricants for effective switch lubrication.

But the development continues. In this one thing is certain every time: working closely with international customers the specialists at FUCHS LUBRITECH will in future continue to bring high tech lubricants to the rails.





KNOW HOW INSTEAD OF CONDENSATE

Wheel flange lubrication is one of the technically most exacting of lubricant applications and places the highest demands on the lubricant.

■ **RAIL-BORNE TRAFFIC** makes use of the low friction coefficients of metallic contact surfaces rolling on each other. In so doing, apart from the action of specific geometric parameters, the safe movement of the wheels on the rails is also ensured by the use of wheel flanges. The wheel flanges also hold the rolling stock safely on the track while traversing curves rapidly. Naturally, this results in metal contact, characterised by a mixed friction that is subject to a

high degree of wear and intensive noise generation. With effective wheel flange lubrication, the lifetime of wheels and rails can be prolonged many times over. For this, a specially designed lubricant, which reduces friction and wear is applied at an exact contact point between the wheel and the rail. The application technique for this has continued to be refined just like the efficiency of the lubricants used. Just as previously with steam locomotives the condensate from

IN PRINCIPLE: ADVANTAGES OF WHEEL FLANGE LUBRICATION

Wear progression with (top) and without (bottom) wheel flange lubrication:

- material loss caused by wear
- additional material loss, which must be taken into account when re-establishing the original profile.

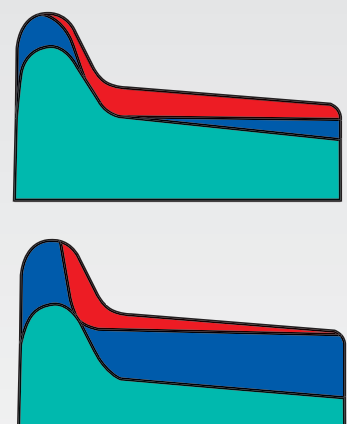

the boiler was frequently used as “lubricant” so nowadays it is the rule that a wheel flange lubricant specially designed for this purpose very quickly pays for itself.

Indirect lubrication ensures a sufficient supply

Present types of wheel flange lubrication equipment are mostly central lubricating systems operated by compressed air, which intermittently spray the minimum possible amounts of lubricant in exact quantities onto the friction points. Thus losses caused by spraying and flinging off are minimised and the lubricant is available where it is needed. To do this, use is made of the principle of indirect lubrication: after the lubricant is applied to the first wheel set a transfer of lubricant particles takes place from the wheel flange to the rail flank at the friction point. The lubricant, which has been introduced in this manner to the rail net-

work is then also taken up and used by the following wheels. In this way it is possible to achieve a safe and sufficient supply of lubricant over the whole rail network. A decisive factor in this is that a sufficient number of rolling stock is fitted with lubrication systems. Typical amounts discharged by present-day lubricating equipment lie between 30 and 100 mm³ per impulse. Depending on the mode of operation of the vehicles, a path-, time- or bend-dependent control of the lubrication systems is recommended. Combinations of these are also possible. The selection of the most suitable procedure is always based on the circumstances of practical operation, such as the speed and route profile, the degree of equipment of the vehicles etc. It is, however, decisive that in all cases the lubrication systems must be optimally adjusted, the spray nozzles correctly aligned and the functional ca-



RAFLUR, Cuabbe, Berlin

pability regularly checked. Even the best lubricant can only work if it can reach the lubrication point.

Small quantities – great effect

The following example shows the low quantities that are sufficient: equipment operated according to distance travelled, which every 500 metres releases a spray impulse with a discharge amount of 30 mm³ will use only 60 grams of wheel flange lubricant over a

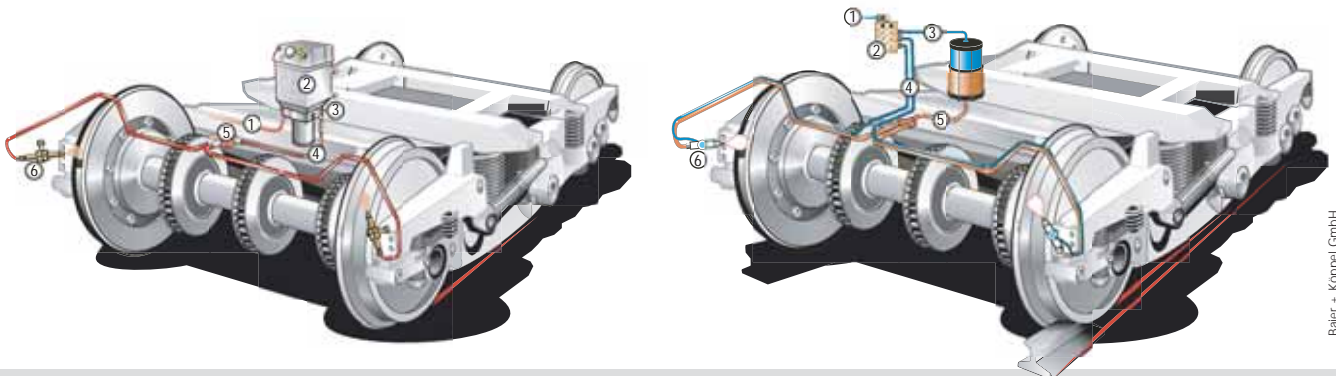

Baler + Koppell GmbH

IN DETAIL: WHEEL FLANGE LUBRICATING EQUIPMENT

Single-line system

- 1 Air supply line
- 2 Non-pressurised lubricant container
- 3 Pneumatic pump
- 4 Line for mixture of air and grease
- 5 Mixing valves
- 6 Spray nozzle

Two-line system

- 1 Air supply line
- 2 Valve block
- 3 Air supply line to pressurised container
- 4 Air line
- 5 Grease line
- 6 Spray nozzle

LOCOLUB ECO provides excellent results at low consumption rates.

distance of 1,000 km. As both sides are normally lubricated, 120 grams are required.

The theoretically calculable lubricant film thickness generated on the sprayed wheel flange upon each spraying pulse is in this case about 0.5 µm. A simple calculation, which proves, in an impressive manner, the high efficiency of a modern wheel flange lubricant such as LOCOLUB ECO with extremely low consumption rates.

Less wear and low costs

The advantages of wheel flange lubrication consist in reduced wear (box "In principle", page 4) on the wheel

flange and rail, in increased derailment prevention and in reduced running noise. As far as wear is concerned, with a non-lubricated wheel flange the operating limit of the wheel flange thickness is very quickly reached. Then a re-profiling of the wheel is necessary, during which a lot of material is machined off. This is at the expense of the wheel diameter, which for its part thus rapidly reaches its size limit. If the diameter falls below the minimum size the wheel must be replaced. If, on the other hand, the wheel flange is effectively lubricated, the thickness of the wheel flange reaches its size limit very much later. Due to this clearly increased mileage of the wheel sets, other limit values such as the wear on the running

IN DETAIL: SPRAY NOZZLE

Binary nozzle with separate feed for lubricant and spraying air with dosage slot and cone nozzle (type Delimon RE).

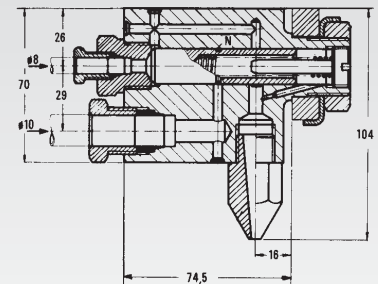

Delimon GmbH

Single nozzle with feed line for lubricant-air mixture (type Beka Fluilub)

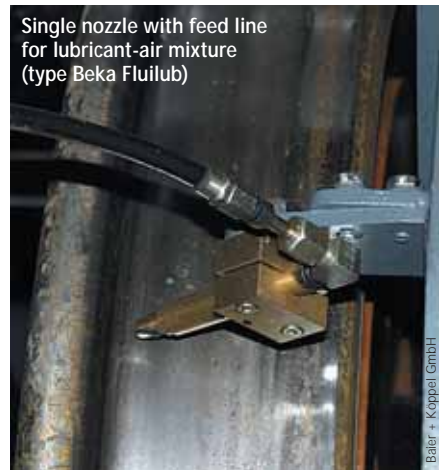

Baker + Kappel GmbH

IN PRACTICE: WEAR REDUCTION IN FIELD TEST

In an extended test period lasting more than two years and covering more than one million running kilometres, one can see the enormous reduction in wear from the use of LOCOLUB ECO in comparison with the conventional "wheel flange lubricant" (former DB material number 077.02) used previously. Both the wheel flange thickness s_d as well as the profile factor q_r show drastic improvements (graphs on the right).

The comparison of the total mileage per wheel until the re-profiling using TRAMLUB F 234 MOD 1 or 2 is illustrated in the graph below:

- without lubrication
- with conventional lubrication
- with SEPULS lubrication system and TRAMLUB F 234 MOD 1 or 2

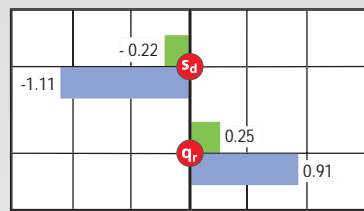
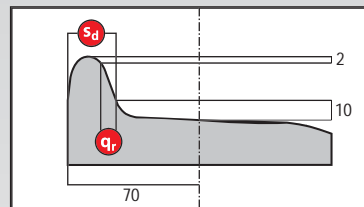

mm/100,000 km

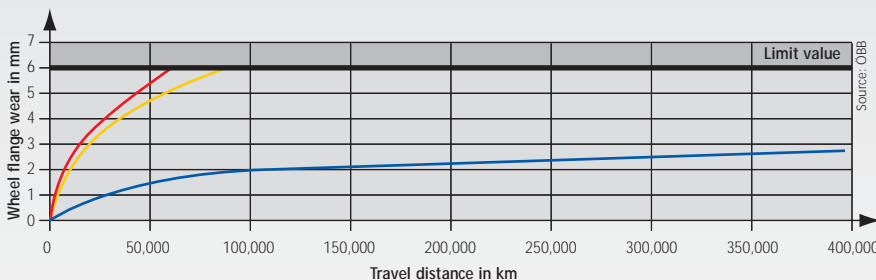

Source: ÖBB

surface are exceeded first in this case. Then re-profiling causes much less material waste so that the wheel set can be overhauled several times before reaching the minimum diameter. Higher availability rates of the vehicles at lower life cycle costs are the result when special high-performance lubricants from FUCHS LUBRITECH are applied. And if then the latter, like LOCOLUB ECO or the products in the TRAMLUB series, are to a large extent biodegradable, that is also beneficial to the image of a transport company, which is subject to public scrutiny like hardly any other undertaking.



HOCHBAHN

FROM FLANK AND SURFACE

Rail lubrication requires good adhesion and high lubricating performance simultaneously.

■ LIKE WHEEL FLANGE LUBRICATION, rail flank lubrication should also decrease friction between wheel flange and rail flank. The difference: rail flank lubrication is done from a stationary

point, that is with lubrication system installed at fixed points along the track.

However a series of alterations in the requirement profile of the lubricant

has resulted from this different application technique. Whereas in the case of wheel flange lubrication fitted on rolling stock the lubricant is sprayed very frequently and in minute quantities onto the friction point and in fact takes place directly before contact between wheel and rail, the stationary rail lubricant must be applied in sufficient quantity onto the rail flank before the train passes the lubrication system. In so doing the lubricant is generally applied only once each time a train passes in order then, by means of a depot effect, to provide a good supply for the axles rolling over it.

To attain the maximum with a minimum

This method of application demands exceptional adhesion on the part of the lubricant and an excellent lubri-



Schöning-Brock GmbH

Practically all Tramlub lubricants can also be applied with special "Hi-Rail" service vehicles.

Environmentally harmless special lubricants from FUCHS LUBRITECH are the clean solution.

cating efficiency. These two properties guarantee that only a minimum of lubricant has to be applied. This aspect is particularly important since, because of the nature of the system, the lubricant is always applied at the same point. Permanent overdosing would cause considerable contamination around the lubrication system. This would not be tolerable even with a biodegradable lubricant. A further important aspect is that in this application, too, the lubricant must guarantee reliable lubrication independent of the weather conditions (sun, rain, cold or ice).

The manufacturers of lubricating equipment have taken up this challenge and today produce a variety of different kinds of lubricating equipment, the control technology of which is usually matched to the particular usage in question. With these electrical, optical, mechanical or magnetic sensors locate the oncoming train and initiate the lubrication process, which applies a specific amount of lubricant to the rail flank. Feeding is usually done via piston pumps or pressurised containers (e.g. with compressed nitrogen). Electric drive units and sometimes also mech-



ESA electronic rail lubricating equipment made by Schreck-Mieves.

IN PRINCIPLE: TRACK-SIDE LUBRICATION SYSTEMS

Schematic representation of a track side lubrication system with storage container, drive, control unit and line system with distributors (type Delimon).

Central system with progressive distributors

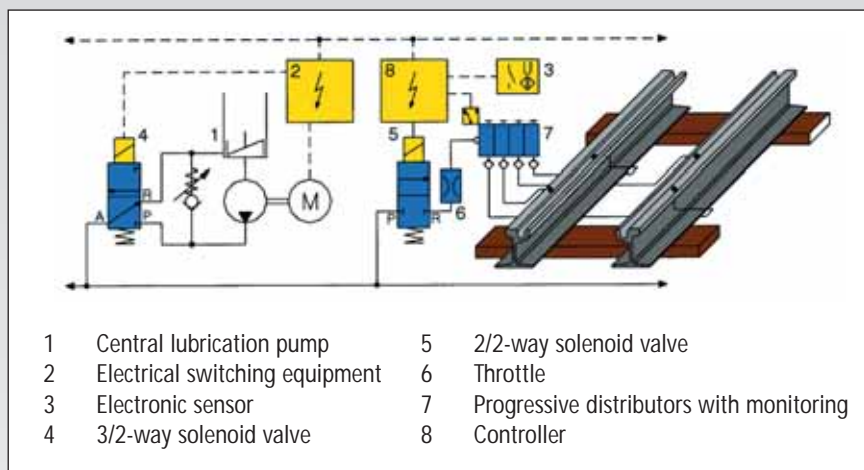

Decentralised system with multiple-line central lubrication pump

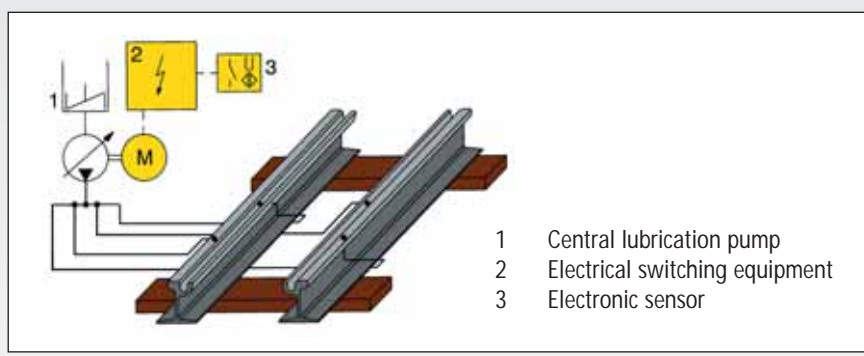

anical ones, e.g. spring-loaded, are also used.

Different systems lead to the goal

Because of the requirement for high adhesion on the part of the lubricant, lubricants of the NLGI grades 1 and 2 are usually used. Most lubricating equipment is designed for such products. With these the path of the lubricant leads from a storage container via tubes and distributors to the so-called lubricating blades, which are clamped or screwed onto the side of the rail running edge. The lubricant escapes from these lubricating blades towards the rail flank and is taken along by the wheel flanges of the wheels rolling past. As an alternative there is the possibility of bringing the lubricant onto the flank of the rails directly and, so-to-speak "from within", through holes drilled in the rails. In addition there are contact-less systems, which work by spraying or squirting the lubricant onto the flank of the rail from a slight distance. Such systems natural-



MVG, Kerstin Groh

IN DETAIL: RAIL WEAR

Typical forms of rail wear: either wear on the running surface of the rails or wear on the flank of the rails predominates according to the operating conditions, though both forms of wear mostly occur in parallel.

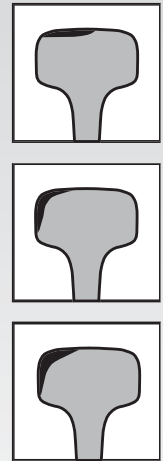

ly require the lubricant used to be of a lower consistency class.

White or black lubricants?

For the methods and possibilities described here FUCHS LUBRITECH provides solutions, which are appropriate for the technical requirement profile and at the same time are formulated using biodegradable components. In particular lubricating greases containing solids have proven themselves due

to the high requirements, whilst nowadays light-coloured solid lubricants are increasingly being used together with the conventional graphite-containing products. The combinations of active reaction white solid lubricants developed by FUCHS LUBRITECH also demonstrate their exceptional wear-preventing properties in the applications described here. In addition these combinations of light-coloured solid lubricants have the advantage, which is not to be underestimated, that they here-

by demonstrate that also light-coloured (that is, non-black) lubricants can be manufactured, which do not suffer from any loss in efficiency.

A solution, which is also ecologically clean in the best sense of the word, both for the employees, who look after the equipment, as well as for the public, in whose field of vision such equipment is often installed.

IN PRACTICE: CEMAFAER LUBRICATION SYSTEM



Cemafer GmbH



Cemafer GmbH

Installation of a track-side rail lubrication system. On the right the drive and control unit with storage containers, on the left the lubricating blades on the rail flanks with the feed pipes.

“ QUIET PLEASE! ”

Rail head treatment reduces curve noise without adversely affecting traction.



■ **PUTTING IT THE WAY WILHELM BUSCH** would put it: Rail transport means loss of poise, because it just makes too much noise. That is certainly not a recent discovery, neither is it one, which only affects rail traffic but it is a fact, which at the present time is attracting more and more attention. The reasons for this are complex. Certainly the population as a whole has nowadays become more critical with regard to matters concerning protection from emissions, whether it is a question of atmospheric pollutants from industrial chimneys or road vehicles, water pollution caused by shipping or industrial waste water or even noise, whoever may be responsible for causing it. On the other hand, because of the expansion of the infrastructure, which is in itself desirable, new traffic routes are necessary, which then, for example, also pass through the new residential areas requiring connection in the form

IN DETAIL: TRAM-SILENCE 00 FOR RAIL HEAD TREATMENT



TRAM-SILENCE 00 on the rail surface.



Application with track-side equipment through holes drilled in the rails.

Thales RSS GmbH



Berliner Verkehrsbetriebe (BVG) Donath

TRAM-SILENCE products control the friction on the rail head and ensure quietness.

of rail networks. This then means that new groups of people, who had previously been spared, are also confronted with traffic noise for the first time and perhaps for this reason are now reacting in a particularly sensitive manner.

Noise has several causes

No matter who he may be, when there is too much squealing on the curves every rail traffic operator is aware of complaints from those living nearby and often also from passengers as well. The dreaded curve squealing is a characteristic of rail traffic, about the causes of which the experts still disagree somewhat and which, in the short term, cannot be controlled with blanket constructive measures. For as soon as a railroad vehicle traverses a curve, transverse forces are created, which pull the vehicle outwards. At the same time tracking forces are created on the wheel

flange, which hold the vehicle on the curve. These forces give rise to very small slipping movements of the wheels in lateral direction, which with the material pairing of metal on metal can lead to high frequency squealing noise. A secondary effect, contributing to noise generation, is longitudinal slip, which is also created when traversing curves.

This occurs with rigid axles on account of the difference in the length of the track on the inside and outside rails. Longitudinal slip can also cause squealing or creaking noise and thus attract the attention of those living nearby.

Specialist journals and conferences meanwhile devote a lot of time to this

IN DETAIL: TYPICAL SOUND SPECTRUM WHEN A TRAM PASSES

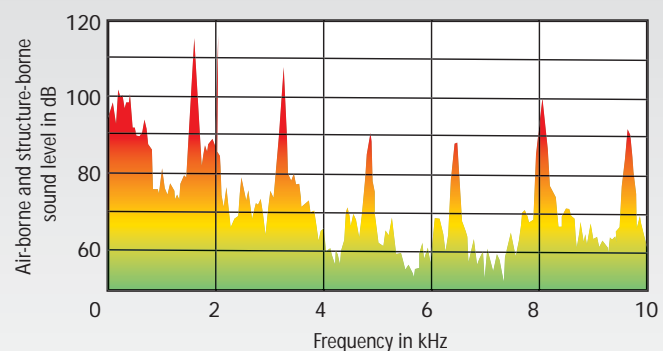



is a distinctive advantage as opposed to other product philosophies, for example, such as the use of lubricating sticks or the use of water or water-based products, which must generally be applied in far greater quantities in order to be able to take effect.

As the exact dosage depends on the respective local conditions, the state of the rails and wheels, the train frequency and similar factors, we recommend the performance of braking tests to prove the adherence to the respectively specified maximum braking paths before implementing such a system. Appropriate explicit evaluations have been made the Railway Federal Office (EBA Eisenbahnbundesamt) as well as according to the rules and regulations for operating trams (BOStrab). Since such investigations could have a considerable effect upon the operational safety of the rolling stock, careful assessment of the amount which is necessary to use is the only sensible course of action.

subject, because these slippage occurrences are able not only to cause noise but also specific forms of wear on wheel and rail. Rippling on the rail surface is particularly feared, which then turns into a new source of noise and which then also substantially increases the mechanical stress on all components of the chassis and the body, thus leading to more consequential damage. Remedial measures range from regular polishing of the rail surfaces through the use of resilient, noise-reducing materials on the track to the construction of noise barriers and the insertion of insulated glazing in dwellings, which are particularly affected.

amounts, already provide them with a fine film of solids. The result is minimal reduction from the friction between wheel and rail, without removing the frictional connection. This is achieved through the correctly matched combination of a rail head treatment agent and an applicator providing the exact dosage. An important advantage of the TRAM-SILENCE products is apparent in such a combination: They can be used with a series of conventional wheel flange and rail lubricating systems in minimal quantities. Or to put it another way: proven technology from these fields can also be employed here. This

Friction control instead of reduction of friction

A very simple and yet at the same time very effective method of noise abatement is often not used long enough for this: treatment of the rail surface with suitable rail head treatment products. The products in the TRAM-SILENCE series are specially designed for this application. These are pasty lubricants with a relatively high content of special solids which, when applied to the rail surfaces even in small





DB AG/Max Lautenschlager

SETTING SWITCHES

Switch lubricants must be able to do a lot more than merely lubricate

■ **SWITCHES ARE REGARDED** as being among the most important elements of rail-borne transport. For they are the things, which enable a change from one track to another and thereby provide the innately rigid rail system with the necessary flexibility and versatility. At the same time switches are among the railway structural parts subject to the most exacting and sensitive demands. Unless they function reliably a smooth-running train service would hardly be possible. Journey times and also travel safety depend upon reliability.

Switches make heavy demands

Easily said and hard to realize; switches have to function in all weather

conditions. In addition low and constant friction is necessary in order – independently of the environmental temperature - to make a smooth and calculable resetting possible. Therefore what matters is the correct switch lubricant. With long-term effect, good adhesive strength and corrosion protective even when, in cases of low-frequency of use, re-lubrication only takes place after weeks. On the other hand, highly-frequented switches are lubricated on a weekly basis while during this interval several hundred setting operations can take place.

A further important factor in the requirement profile arises from the desire to be able to treat as far as possi-



As in the past switch lubrication is mainly manual work.

ble all moving parts of a switch, which are scheduled for re-lubrication, with a single lubricant.

For as in the past a lot of manual work is involved in switch lubrication because every single switch slide chair must be provided with lubricant and, naturally, previously also be freed from dust, dirt and foliage. In inaccessible places this demands high creep properties of the lubricant with good adhesive strength at the same time.

Apart from semi-fluid greases, low-viscosity fluids are also used here, which have certain advantages during application. However, in this case particular attention must be paid that the easy processing ability does not take place at the expense of the durability of the lubricating film or its water resistance. FUCHS LUBRITECH also offers optimal product solutions for these requirements.

IN PRINCIPLE: TEST RIG FOR SWITCH LUBRICANTS

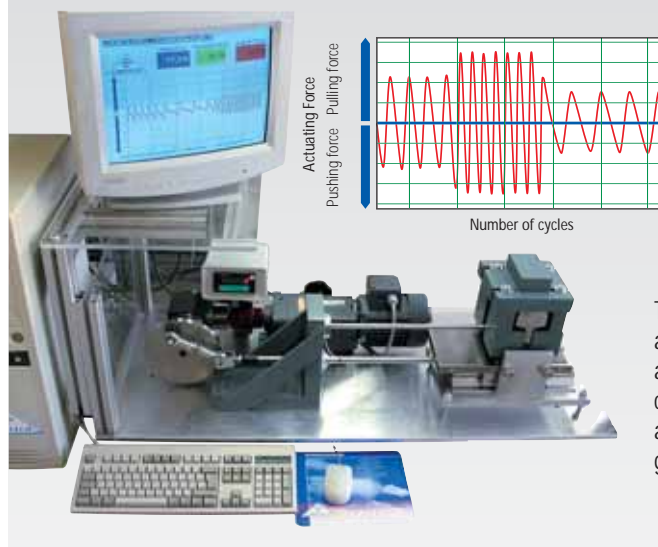

Testing of the lubricants as far as possible in accordance with practical conditions is the alpha and omega of targeted development

Environmentally harmless and efficient

A great deal of experience and intuitive feeling went into creating a switch lubricant, which would best fulfil these requirements. With TRAMLUB

384 G PLUS and the other types in this series, environmentally harmless high-performance lubricants are available, which have set standards as regards corrosion protection, adhesion, suitability in cold environments, creeping capability, UV stability and biodegradability.



EFFECTIVE MAINTENANCE

Complete workshop demand – products for assembly, maintenance, care and repair.

■ **MAINTENANCE AND REPAIR** of vehicles, machines and systems is a diverse field of activities demanding considerable attention and flexibility.

If the special lubricants for the wheel-rail contact described at the beginning contribute to a drastic reduction of the wear on wheels and rails, the maintenance costs can also be reduced and the service life of the components can be increased in other application fields by the

use of high-performance lubricants. The following double page lists some of these special applications and states the special lubricant



most suitable for the respective purpose.

But even when optimal lubricants are used, maintenance and repair cannot be completely avoided. Here too, FUCHS LUBRITECH offers the entire

range from one source. In the following table, the most important products are represented with their typical fields of application. As the spray can is usually the best form of application, the corresponding products are separately marked.

APPLICATION AREA ↘	PRODUCTS ↘	available as spray
Bolt and joint lubrication, general grease lubrication	LAGERMEISTER 3000 PLUS, LAGERMEISTER TS, LAGERMEISTER WHS 2002, URETHYN E/M	
Gearwheel lubrication	CEPLATTYN 300	
Rust loosening and dewatering oils, fine lubrication	FERROFORM SUPER 7, FERROFORM LOCC, FERROFORM ECO 871, FERROFORM ECO LOCC	
Parting and preserving	STABYLAN SI 210, STABYLAN SI 310, gleitmo 300	
Assembly and screw lubrication	gleitmo 100 S, gleitmo 165, gleitmo WSP 5040	
Cleaning and corrosion protection	DECORDYN W, METABLANC METABLANC ECO (not available as spray)	
Chain lubrication	STABYLAN G 1000, STABYLAN W 880, STABYLAN 2001, STABYLAN 5006	
Wire rope lubrication	CEDRACON, CEDRACON DS, CEDRACON K	
Dry lubrication	gleitmo 900, gleitmo 961, gleitmo 980	

Further products on request. Subject to alteration.

SPECIAL LUBRICANTS IN RAILWAY APPLICATIONS

■ **OF COURSE THE LUBRICANTS** for the various types of wheel-rail contact take up a particularly important position in rail transport. Malfunctions of the lubricant can affect safety. For this reason, the highest quality demands are set on these lubricants and their manufacturers.

However there are a great deal of other lubrication points on railroad vehicles, where the use of special lubricants quickly pays off. The following overview shows some of these application fields and states the appropriate FUCHS LUBRITECH special agent for the purpose.

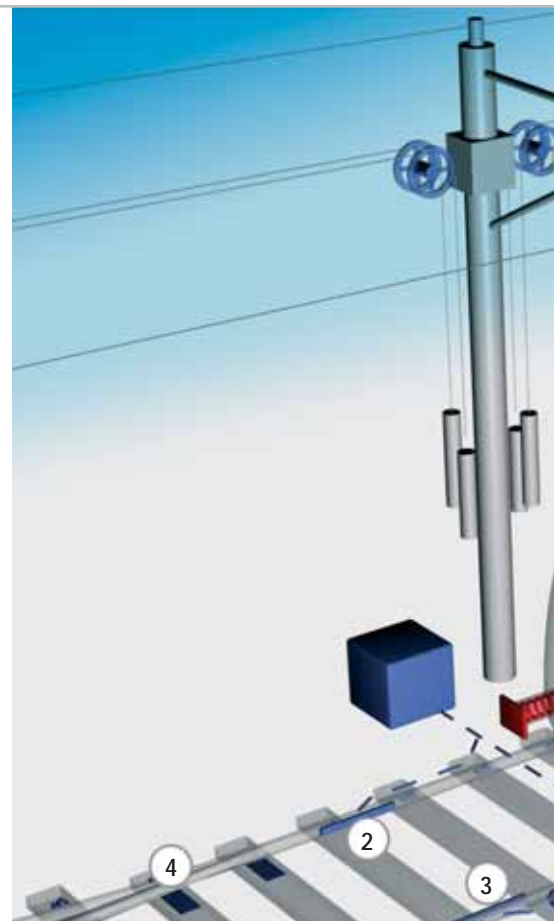

1. Lubrication of Wheel Flanges

- Application by means of automatic lubricant spraying equipment (from the vehicle).
- Minimum quantities giving a high degree of protection against wear and tear are sprayed on in fine doses.
- Products: **LOCOLUB ECO, TRAMLUB F 234 MOD 2**

2. Rail Flank Lubrication

- Application using stationary, automatic lubricating equipment on wear-intensive stretches of track.
- Use of particularly adhesive, consistent lubricants.
- Products: **TRAMLUB SSM ECO, TRAMLUB F 234-series**

3. Rail Head Treatment

- Economical, manual or automatic application directly onto the rail head.
- Reduces noise, caused by contact between rail and wheel set when going round tight curves.
- Products: **TRAM-SILENCE-series**

4. Lubrication of Switching Points

- Manual or semi-automatic application using a brush or special points' lubricating equipment.
- Long-life lubricant with very good anti-corrosion properties and ability to withstand extremely compressive loads.
- Products: **TRAMLUB 384 G PLUS, TRAMLUB SPL-F1, TRAMLUB W-series**

5. T-head Bolts **DECORDYN HF 91**

Long-term corrosion protection wax with outstanding protective effect for all small iron parts used in fastening rails, especially also for T-head bolts (also very suitable as a replacement for the tar used previously).

6. Buffer Plates **CEPLATTYN ECO 300 PLUS**

Environmentally harmless adhesive lubricant with a high-performance combination of solid lubricants; extremely adhesive, protecting against corrosion, water resistant and wear reducing. Excellent for lubrication of sliding surfaces on buffer plates and similar loaded elements.

7. Annular Springs **gleitmo WSP 5040, gleitmo 805**

High-performance grease pastes based on active reaction white solid lubricants; excellent uniform friction behaviour permits smooth compression

and release of the spring over a long period of use; this brings about a significant increase in travelling comfort compared with the use of traditional grease.

8. Slewing Rings and Turntables **gleitmo 585 K**

Fully synthetic high-performance lubricating grease with active reaction white solid lubricants; these permit reliable and wear-free lubrication of the ball or roller slewing rings and turntables, also under adverse use conditions, such as under high impact and oscillation stress with simultaneously small pivoting angles, high loads, low and high temperatures.

9. Wheel Set Bearings **LAGERMEISTER XXL**

Novel special soap-free lubricating grease for long-term lubrication of highly stressed roller bearings; wide operating temperature range, high load bearing capacity and even lubrication performance at low and high running speeds.

10. Mounting of Wheel Set Bearings **gleitmo 100, gleitmo 700**

High-grade assembly pastes based on molybdenum disulphide; guarantee low, constant ratio of friction when mounting and thereby a reproducible, reliable assembly process.

11. Axle Gear Boxes **GEARMASTER ECO-series**

High-performance gear oils based on fully-synthetic ester oils; with excellent lubrication performance even in the mixed friction area, high resistance to ageing and outstanding load carrying capacity.

12. Drive Motor Bearings and Generator Bearings **URETHYN E/M 2**

Semi-synthetic high-temperature grease for rapidly revolving roller bearings permits lengthy lubrication intervals even at high operating temperatures; reliable lubrication performance over

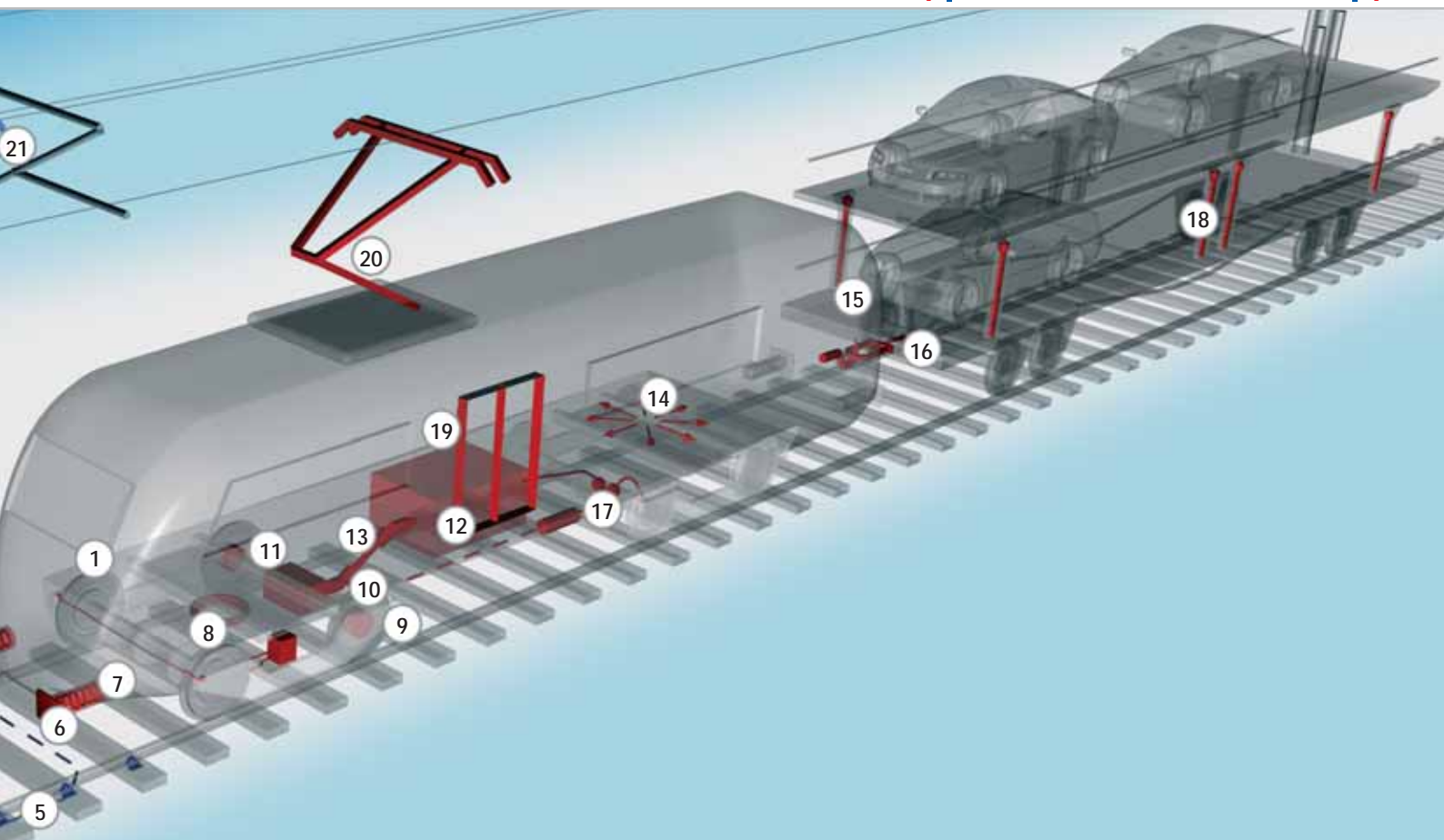

lengthy periods of use permits safe operation of drive motor and generator bearings.

13. Cardan Drive Shafts **gleitmo 805, gleitmo 810**

High-performance grease pastes with active reaction white solid lubricants; permit low wear use of highly-stressed cardan shafts, reliable lubrication of universal joints, sliding fits and overload safety devices.

14. Bogie / Bolt connections **gleitmo WSP 5040, gleitmo 805**

High-performance grease pastes based on active reaction white solid lubricants; extremely high load carrying capacity also under strong dynamic loading; excellent corrosion protection even in an aggressive environment such as, e.g. spray and salt water; use as installation aid as well as for the operational lubrication of bolt and screw connections; these permit trouble-free loosening of the connection even after a long period of use. For re-lubrication gleitmo 805 is used, which can be applied in traditional grease guns.

15. Couplers and Drawgear **CEPLATTYN ECO 300 PLUS**

Environmentally harmless adhesive lubricant with a high-performance combination of solid lubricants; extremely adhesive, protecting against corrosion, water resistant and wear reducing. Excellently suitable for lubrication of sliding surfaces and screw-type couplers in the coupler and drawgear elements as well as for manual brake spindles, gear racks and open gear wheels.

16. Railway Couplings **LAGERMEISTER 3000 PLUS**

Long-term lubricating grease on a semi-synthetic base; outstandingly suitable as an universal lubricant for all grease-lubricated parts on railway couplings. High adhesion and extraordinary water-resistance permit long-lasting, reliable lubrication and protection against wear and corrosion.

DECORDYN 350

Temporary anti-corrosion film for all metallic components, which unexpectedly, but reliably have to be protected against corrosion. Is simply applied by spraying or with a brush and, after the solvent has evaporated, forms a thin, almost non-slip protective film, which normally does not have to be removed even when the stored components are subsequently used.

17. Compressed Air Conditioners **KOMPRANOL GRÜN**

Environmentally harmless fluid for compressed air conditioners; high lubrication performance and good water absorption capability permit the compressed air plant to operate reliably.

18. Lifting Spindles **gleitmo WSP 5040**

High-performance grease paste based on active reaction white solid lubricants; excellent pressure absorption capability with constant, low friction behaviour for lubrication of the trapezoidal thread on heavy load lifting equipment enabling safe, wear-free operation of the lifting spindles.

19. Door Seals **gleitmo 300**

Dry lubricating film, grease- and oil-free; is outstandingly suitable for the care and maintenance

of rubber door seals, does not discolour or stain, fulfils a long-lasting lubricating and protective function; also for numerous other applications for lubricating plastic and/or elastomer parts in sliding contact (pushing- and sliding guides, e.g. drawers, curtain rails etc.).

20. Pantographs **STABYL LT 50**

Long-term low-temperature grease is especially suitable for all moving connections on the pantograph on account of its wide operating temperature range, also extremely suitable for roller and plain bearings at low operating temperatures.

21. Wheel Tensioners **URETHYN LT 60**

Long-term lubrication of the bearings, excellent temperature resistance and even lubrication performance over a wide operating temperature range permit lengthy re-lubrication intervals with trouble-free operation.

gleitmo SFL 9540

Solid film lubricant for the wheel tensioner axles optimises the friction behaviour and ensures uniform, smooth equalisation of variations in the contact wire tension caused by temperature and oscillation.

Precasted Concrete Parts **SOK 912, SOK AQUA**

Modern high-performance release agents for the manufacture of a wide variety of pre-cast concrete parts, from concrete sleepers through sections of the permanent way to centrifugally-made concrete poles and bridge girders.

SPECIAL LUBRICANTS FOR RAIL TRAFFIC



Berliner Verkehrsbetriebe (BVG) - Donath

■ **NOTE:** This selection guide simply contains a selection of the main fields of application. For unusual applications, please refer to the responsible customer service staff or product manager. The product recommendations are related to our current product range and are based on past experience. They do not represent any guarantee of function in every individual case.

Further products on request. Subject to alteration.

FIELDS OF APPLICATION

Product code

Rail flank lubrication (stationary)

Cemafer, side box ▶

Cemafer, underground ▶

Delimon StaTrack ▶

Lincoln ▶

Moklansa / V-Tec, E3S ▶

Portec PL ▶

Railpartner / SRS Clicomatic ▶

Schreck-Mieves, ESA ▶

Wheel flange lubrication (mobile)

Baier + Köppel Fluilub ▶

Delimon Railjet ▶

Delimon RE ▶

Knorr-Bremse / Rexroth / Wabco ▶

ÖBB, Sepuls ▶

Rebs ▶

Saxonia SSL-3 ▶

Sécheron, GB-L ▶

Sécheron, GB-G ▶

Vogel SP 8, SP 9 ▶

Vogel Tram ▶

Woerner ▶

Maintenance vehicle ▶

General applications

Annular springs ▶

Assembly ▶

Axle oil ▶

Bolt connections ▶

Buffer plates ▶

Cardan shafts ▶

Compressed air generation ▶

Door seals ▶

Drive motors and generator bearings ▶

Gear wheels/toothed racks ▶

Handbrake spindles ▶

Hom cheeks ▶

Hydraulics ▶

Lifting spindles ▶

Pantographs ▶

Points slide chairs ▶

Railway couplings, corr. protection ▶

Railway couplings, lubrication ▶

Revolving joints, steering rings ▶

Screw coupling ▶

Sliding surfaces ▶

Switch drives ▶

T-head bolts, corrosion protection ▶

Tilting bearings ▶

Traction gears ▶

Wheel set bearings ▶

Wheel tensioners ▶

Wire ropes ▶



Lubrication Technology



FUCHS LUBRITECH GMBH

Hans-Reiner-Str. 7-13
67685 Weilerbach/Germany
www.fuchs-lubritech.com

Phone +49 (0) 6374 924-5
Fax +49 (0) 6374 924-940
E-Mail info@fuchs-lubritech.de

